

---

**User's  
Manual**

***YTA*** Series

**YTA70P  
Temperature Transmitter**

IM 01C50C05-01EN

---

**vigilantplant.**<sup>®</sup>

---

**YOKOGAWA**   
Yokogawa Electric Corporation

IM 01C50C05-01EN  
2nd Edition

# YTA70P

## Temperature Transmitter

IM 01C50C05-01EN 2nd Edition

## CONTENTS

<b>1. Preface</b>	<b>1-1</b>
■ Notes on the User's Manual	1-1
■ Notes on Safety and Modifications	1-1
■ Notes on Factory settings	1-2
■ For Safe Use of Product	1-2
■ Symbols used in this manual	1-3
■ Warranty	1-4
■ Waste Electrical and Electronic Equipment (WEEE) Directive	1-5
■ The Authorized Representative for this product in the EEA is:	1-5
■ Manual number	1-5
■ Trademarks	1-5
■ ATEX Documentation	1-6
<b>2. Notes on Handling</b>	<b>2-1</b>
2.1 Label	2-2
2.2 Transport	2-2
2.3 Storage	2-3
2.4 Choosing the Installation Location	2-3
2.5 Use of a Transceiver	2-4
2.6 Withstand Voltage Test	2-4
2.7 Installation of Explosion Protected Type Transmitters	2-5
2.7.1 ATEX Certification	2-5
2.7.2 FM Certification	2-5
2.7.3 IECEx Certification	2-5
2.7.4 CSA Certification	2-5
2.7.5 Label of Explosion Protected Type	2-5
<b>3. Part Names</b>	<b>3-1</b>
<b>4. Installation</b>	<b>4-1</b>

<b>5. Wiring</b>	<b>5-1</b>
5.1 Notes on Wiring	5-1
5.2 Loop Construction	5-1
5.3 Cable Selection	5-3
5.3.1 Input signal Cable Selection	5-3
5.3.2 Output Signal Cable Selection	5-3
5.4 Cable and Terminal Connections	5-3
<b>6. Maintenance</b>	<b>6-1</b>
6.1 General	6-1
6.2 Trim adjustment	6-1
6.2.1 Trim Procedure	6-1
6.3 Troubleshooting	6-3
<b>7. General Specifications</b>	<b>7-1</b>
7.1 Standard Specifications	7-1
7.2 Model and Suffix Codes	7-4
7.3 Optional Specifications	7-4
7.4 Dimensions	7-6
<b>8. HART Communicator Operation</b>	<b>8-1</b>
8.1 Connection and Requirements	8-1
8.2 Parameters	8-2
8.3 Device Variables Mapping	8-12
8.4 Parameter List	8-14
<b>Appendix1. ATEX Installation drawing YTA70PQA01</b>	<b>A-1</b>
<b>Appendix2. FM Installation drawing YTA70PQF01</b>	<b>A-3</b>
<b>Appendix3. IECEx Installation drawing YTA70PQI01</b>	<b>A-4</b>
<b>Appendix4. CSA Installation drawing YTA70PQC01</b>	<b>A-6</b>
<b>Appendix5. Label of Explosion Protected Type</b>	<b>A-7</b>
<b>Parts List for Connectors</b>	
<b>Revision Information</b>	

# 1. Preface

The YTA70P temperature transmitter is fully factory-tested according to the specifications indicated on the order.

In order for the YTA70P temperature transmitter to be fully functional and to operate in an efficient manner, the manual must be carefully read to become familiar with the functions, operation, and handling of the YTA70P. This manual gives instructions on handling, wiring and maintenance of YTA70P temperature transmitters. Changing the parameter settings requires a terminal dedicated to the HART protocol . For details on how to set the parameters of these transmitters, refer to chapter 8.

## ■ Notes on the User's Manual

- This manual should be delivered to the end user.
- The information contained in this manual is subject to change without prior notice.
- The information contained in this manual, in whole or part, shall not be transcribed or copied without notice.
- In no case does this manual guarantee the merchant ability of the transmitter or its adaptability to a specific client need.
- Should any doubt or error be found in this manual, submit inquiries to your local dealer.
- No special specifications are contained in this manual.
- Changes to specifications, structure, and components used may not lead to the revision of this manual unless such changes affect the function and performance of the transmitter.

## ■ Notes on Safety and Modifications

- Before handling the YTA70P, it is absolutely imperative that users of this equipment read and observe the safety instructions mentioned in each section of the manual in order to ensure the protection and safety of operators, the YTA70P itself and the system containing the transmitter. We are not liable for any accidents arising out of handling that does not adhere to the guidelines established in the safety instructions.

**■ Notes on Factory settings**

- Model YTA70P is shipped with the ordering settings from the factory. The label information is shown in Chapter 2.1. The factory setting information refer to Chapter 7.1.

**■ For Safe Use of Product**

Please give your attention to the followings.

**(a) Installation**

- The instrument must be installed by an expert engineer or a skilled personnel. The procedures described about INSTALLATION are not permitted for operators.
- All installation shall comply with local installation requirement and local electrical code.

**(b) Wiring**

- The instrument must be installed by an expert engineer or a skilled personnel. The procedures described about WIRING are not permitted for operators.
- Please confirm that voltages between the power supply and the instrument before connecting the power cables and that the cables are not powered before connecting.

**(c) Maintenance**

- Please do not carry out except being written to a maintenance descriptions. When these procedures are needed, please contact nearest YOKOGAWA office.

**(d) Modification**

- Yokogawa will not be liable for malfunctions or damage resulting from any modification made to this instrument by the customer.

## ■ Symbols used in this manual

The YTA70P temperature transmitter and this manual use the following safety related symbols and signals.



### **WARNING**

---

Contains precautions to protect against the chance of explosion or electric shock which, if not observed, could lead to death or serious injury.

---



### **CAUTION**

---

Contains precautions to protect against danger, which, if not observed, could lead to personal injury or damage to the instrument.

---



### **IMPORTANT**

---

Contains precautions to be observed to protect against adverse conditions that may lead to damage to the instrument or a system failure.

---



### **NOTE**

---

Contains precautions to be observed with regard to understanding operation and functions.

---

Some of the diagrams in this manual are partially omitted, described in writing, or simplified for ease of explanation. The screen drawings contained in the instruction manual may have a display position or characters (upper/lower case) that differ slightly from the full-scale screen to an extent that does not hinder the understanding of functions or monitoring of operation.

## ■ Warranty

The warranty period of the instrument is as of condition shown when purchasing.

Any trouble arising during the warranty period shall be replaced at free of charge.

The following problems or troubles shall not be eligible of charge-exempt repair.

- Caused by improper usage or storage of the customer which exceeds the specification requirements.
- Caused by mishandling or modification.
- Caused by fire, earthquake or other acts of God that are not directly a result of problems of the instrument.
- **Conditions not eligible for charge-exempt repair.**
  - Problems caused by improper or insufficient maintenance on the part of the customer.
  - Trouble or damage caused by mishandling, misuse, or storage that exceeds the design or specification requirements.
  - Problems caused by improper installation location or by maintenance conducted in a non-conforming location.
  - Trouble or damage was caused by modification or repair that was handled by a party or parties other than our consigned agent.
  - Trouble or damage was caused by inappropriate relocation following delivery.
  - Trouble or damage was caused by fire, earthquake, wind or flood damage, lightning strikes or other acts of God that are not directly a result of problems with this instrument.

■ **Waste Electrical and Electronic Equipment (WEEE) Directive**  
**(This directive is only valid in the EU)**

This product complies with the WEEE Directive marking requirement.

The following marking indicates that you must not discard this electrical/electronic product in domestic household waste.

Product Category

With reference to the equipment types in the WEEE directive Annex 1, this product is classified as a “Monitoring and Control instrumentation” product.

Do not dispose in domestic household waste.

When disposing products in the EU, contact your local Yokogawa Europe B.V. office.



■ **The Authorized Representative for this product in the EEA is:**

Yokogawa Europe B.V.

Euroweg 2, 3825 HD Amersfoort, THE NETHERLANDS.

■ **Manual number**

The last two characters of the manual number and general specification number indicate the language in which the manual is written.

■ **Trademarks**

- HART is a trademark of the HART Communication Foundation.
- Registered trademarks or trademarks appearing in this manual are not designated by a TM or ® symbol.
- Other company names and product names used in this manual are the registered trademarks or trademarks of their respective owners.



## ■ ATEX Documentation

This procedure is only applicable to the countries in European Union.

GB

All instruction manuals for ATEX Ex related products are available in English, German and French. Should you require Ex related instructions in your local language, you are to contact your nearest Yokogawa office or representative.

DK

Alle brugervejledninger for produkter relateret til ATEX Ex er tilgængelige på engelsk, tysk og fransk. Skulle De ønske yderligere oplysninger om håndtering af Ex produkter på eget sprog, kan De rette henvendelse herom til den nærmeste Yokogawa afdeling eller forhandler.

I

Tutti i manuali operativi di prodotti ATEX contrassegnati con Ex sono disponibili in inglese, tedesco e francese. Se si desidera ricevere i manuali operativi di prodotti Ex in lingua locale, mettersi in contatto con l'ufficio Yokogawa più vicino o con un rappresentante.

E

Todos los manuales de instrucciones para los productos antiexplosivos de ATEX están disponibles en inglés, alemán y francés. Si desea solicitar las instrucciones de estos artículos antiexplosivos en su idioma local, deberá ponerse en contacto con la oficina o el representante de Yokogawa más cercano.

NL

Alle handleidingen voor producten die te maken hebben met ATEX explosiebeveiliging (Ex) zijn verkrijgbaar in het Engels, Duits en Frans. Neem, indien u aanwijzingen op het gebied van explosiebeveiliging nodig hebt in uw eigen taal, contact op met de dichtstbijzijnde vestiging van Yokogawa of met een vertegenwoordiger.

SF

Kaikkien ATEX Ex -tyyppisten tuotteiden käyttöohjeet ovat saatavilla englannin-, saksan- ja ranskankielisinä. Mikäli tarvitsette Ex -tyyppisten tuotteiden ohjeita omalla paikallisella kielellänne, ottakaa yhteyttä lähimpään Yokogawa-toimistoon tai -edustajaan.

P

Todos os manuais de instruções referentes aos produtos Ex da ATEX estão disponíveis em Inglês, Alemão e Francês. Se necessitar de instruções na sua língua relacionadas com produtos Ex, deverá entrar em contacto com a delegação mais próxima ou com um representante da Yokogawa.

F

Tous les manuels d'instruction des produits ATEX Ex sont disponibles en langue anglaise, allemande et française. Si vous nécessitez des instructions relatives aux produits Ex dans votre langue, veuillez bien contacter votre représentant Yokogawa le plus proche.

D

Alle Betriebsanleitungen für ATEX Ex bezogene Produkte stehen in den Sprachen Englisch, Deutsch und Französisch zur Verfügung. Sollten Sie die Betriebsanleitungen für Ex-Produkte in Ihrer Landessprache benötigen, setzen Sie sich bitte mit Ihrem örtlichen Yokogawa-Vertreter in Verbindung.

S

Alla instruktionsböcker för ATEX Ex (explosionssäkra) produkter är tillgängliga på engelska, tyska och franska. Om Ni behöver instruktioner för dessa explosionssäkra produkter på annat språk, skall Ni kontakta närmaste Yokogawakontor eller representant.

GR

Όλα τα εγχειρίδια λειτουργίας των προϊόντων με ATEX Ex διατίθενται στα Αγγλικά, Γερμανικά και Γαλλικά. Σε περίπτωση που χρειάζεστε οδηγίες σχετικά με Ex στην τοπική γλώσσα παρακαλούμε επικοινωνήστε με το πλησιέστερο γραφείο της Yokogawa ή αντιπρόσωπο της.

SK

Všetky návody na obsluhu pre prístroje s ATEX Ex sú k dispozícii v jazyku anglickom, nemeckom a francúzskom. V prípade potreby návodu pre Ex-prístroje vo Vašom národnom jazyku, skontaktujte prosím miestnu kanceláriu firmy Yokogawa.

CZ

Všechny uživatelské příručky pro výrobky, na něž se vztahuje nevýbušné schválení ATEX Ex, jsou dostupné v angličtině, němčině a francouzštině. Požadujete-li pokyny týkající se výrobků s nevýbušným schválením ve vašem lokálním jazyku, kontaktujte prosím vaši nejbližší reprezentační kancelář Yokogawa.

LT

Visos gaminiø ATEX Ex kategorijos Eksploatavimo instrukcijos teikiami anglø, vokieèiø ir prancùzø kalbomis. Norëdami gauti prietaisø Ex dokumentacijà kitomis kalbomis susisiekite su artimiausiu bendrovës “Yokogawa” biuru arba atstovu.

LV

Visas ATEX Ex kategorijas izstrādājumu Lietošanas instrukcijas tiek piegādātas angļu, vācu un franču valodās. Ja vēlaties saņemt Ex ierīšu dokumentāciju citā valodā, Jums ir jāsazinās ar firmas Jokogava (Yokogawa) tuvāko ofisu vai pārstāvi.

EST

Kõik ATEX Ex toodete kasutamishendid on esitatud inglise, saksa ja prantsuse keeles. Ex seadmete muukeelse dokumentatsiooni saamiseks pöörduge lähima lokagava (Yokogawa) kontori või esindaja poole.

PL

Wszystkie instrukcje obsługi dla urządzeń w wykonaniu przeciwwybuchowym Ex, zgodnych z wymaganiami ATEX, dostępne są w języku angielskim, niemieckim i francuskim. Jeżeli wymagana jest instrukcja obsługi w Państwa lokalnym języku, prosimy o kontakt z najbliższym biurem Yokogawy.

SLO

Vsi predpisi in navodila za ATEX Ex sorodni pridelki so pri roki v angleščini, nemščini ter francoščini. Če so Ex sorodna navodila potrebna v vašem tujejnem jeziku, kontaktirajte vaš najbliži Yokogawa office ili predstavnika.

H

Az ATEX Ex műszerek gépkönyveit angol, német és francia nyelven adjuk ki. Amennyiben helyi nyelven kérjük az Ex eszközök leírásait, kérjük keressék fel a legközelebbi Yokogawa irodát, vagy képviselőt.

BG

Всички упътвания за продукти от серията ATEX Ex се предлагат на английски, немски и френски език. Ако се нуждаете от упътвания за продукти от серията Ex на родния ви език, се свържете с най-близкия офис или представителство на фирма Yokogawa.

RO

Toate manualele de instructiuni pentru produsele ATEX Ex sunt in limba engleza, germana si franceza. In cazul in care doriti instructiunile in limba locala, trebuie sa contactati cel mai apropiat birou sau reprezentant Yokogawa.

M

Il-manwali kollha ta' l-istruzzjonijiet għal prodotti marbuta ma' ATEX Ex huma disponibbli bi-Ingliż, bi-Ġermaniż u bi-Franċiż. Jekk tkun teħtieġ struzzjonijiet marbuta ma' Ex fil-lingwa lokali tiegħek, għandek tikkuntattja lill-eqreb rappreżentant jew ufficiċju ta' Yokogawa.

## 2. Notes on Handling

The YTA70P temperature transmitter is fully factory tested upon shipment. When the YTA70P is delivered, check the appearance for damage, and also check that the transmitter parts shown in Figure 2.1 are included with your shipment.

Temperature Transmitter  
YTA70P

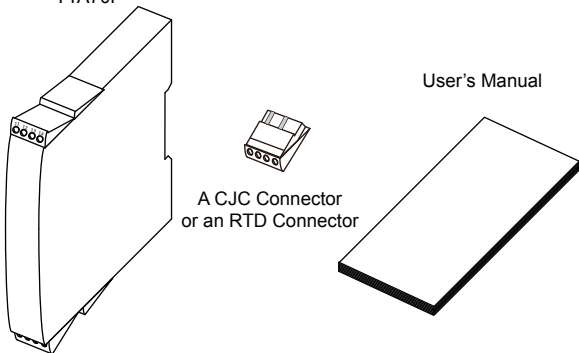

A CJC or an RTD connector is attached to the product as specified in the order, and the connector not attached to the product is included in the package.

F0201.ai

**Figure 2.1** Transmitter parts

## 2.1 Label

The model name and configuration are indicated on the Label. Verify that the configuration indicated in the “Model and Suffix Code” in Chapter 7 is in compliance with the specifications written on the order sheet.

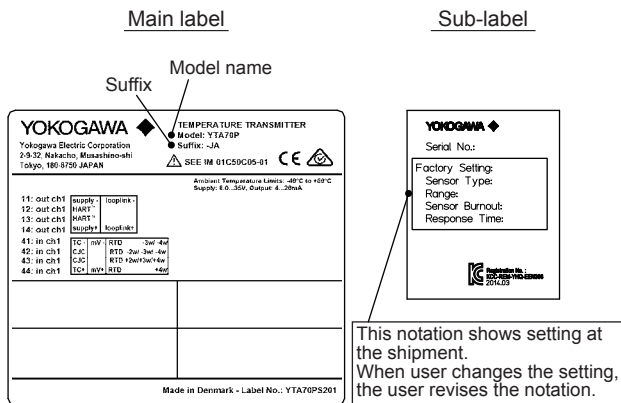

F0202.ai

Figure2.2 Labels

## 2.2 Transport

To prevent damage while in transit, leave the transmitter in the original shipping container until it reaches the installation site.

## 2.3 Storage

When an extended storage period is expected, observe the following precautions:

1. If at all possible, store the transmitter in factory shipped condition, that is, in the original shipping container.
2. Choose a storage location that satisfies the following requirements.
  - A location that is not exposed to rain or water.
  - A location that is not exposed to direct sunlight.
  - A location subject to a minimum of vibration or impact.
  - The following temperature and humidity range is recommended.  
Ordinary temperature and humidity (25°C, 65%) are preferable.  
Temperature: -40 to 85°C  
Humidity: 0 to 95% RH (Non-Condensation)

## 2.4 Choosing the Installation Location

Although the temperature transmitter is designed to operate in a vigorous environment, to maintain stability and accuracy, the following is recommended:

### (1) Ambient Temperature

It is preferable to not to expose the instrument to extreme temperatures or temperature fluctuations. If the instrument is exposed to radiation heat a thermal protection system and appropriate ventilation is recommended.

### (2) Environmental Requirements

Do not allow the instrument to be installed in a location that is exposed to corrosive atmospheric conditions. When using the instrument in a corrosive environment, ensure the location is well ventilated. The unit and its wiring should be protected from exposure to rainwater and direct sunlight.

### (3) Impact and Vibration

It is recommended that the instrument be installed in a location that is subject to a minimum amount of impact and vibration.

## 2.5 Use of a Transceiver

Although the temperature transmitter is designed to resist influence from high frequency noise; use of a transceiver in the vicinity of installation may cause problems. Installing the transmitter in an area free from high frequency noise (RFI) is recommended.

## 2.6 Withstand Voltage Test



### CAUTION

---

- Overvoltage of the test voltage that is so small that it does not cause an dielectric breakdown may in fact deteriorate insulation and lower the safety performance; to prevent this it is recommended that the amount of testing be kept to a minimum.
  - The voltage for the withstand voltage test must be 500 VAC or lower. Failure to heed these guidelines may cause faulty operation.
- 

### Withstand voltage test procedure

- Testing between the output terminal and the input terminal
  1. Lay transition wiring between 11 and 14 of connector. \*1
  2. Lay transition wiring between all input terminals (except CJC) of connector. \*1
  3. Connect the withstand voltage tester (with the power turned OFF) between the transition wiring shown in steps 1 and 2 above.
  4. After setting the current limit value of the withstand voltage tester to 10 mA, turn the power ON, and carefully increase the impressed voltage from 0 V to the specified value.
  5. The voltage at the specified value must remain for duration of one minute.
  6. Upon completion of the test, carefully reduce the voltage so that no voltage surge occurs.

\*1: Refer to Figure 5.3 for terminal Number.



## 2.7 Installation of Explosion Protected Type Transmitters

In this section, further requirements and differences and for explosion protected type instrument are described. For explosion protected type instrument, the description in this chapter is prior to other description in this user's manual.



### CAUTION

---

To preserve the safety of explosion protected type instrument requires great care during mounting, wiring.

Safety requirements also place restrictions on maintenance and repair activities. Please read the following sections very carefully.

---

### 2.7.1 ATEX Certification

See Appendix.1 ATEX Installation drawing YTA70PQA01

### 2.7.2 FM Certification

See Appendix.2 FM Installation drawing YTA70PQF01

### 2.7.3 IECEx Certification

See Appendix.3 IECEx Installation drawing YTA70PQI01

### 2.7.4 CSA Certification

See Appendix.4 CSA Installation drawing YTA70PQC01

### 2.7.5 Label of Explosion Protected Type

See Appendix.5 Label of Explosion Protected Type



### NOTE

---

The YTA70P is a single sensor input model.

Please ignore the loop construction of CH2.

---

### 3. Part Names

Temperature Transmitter  
YTA70P

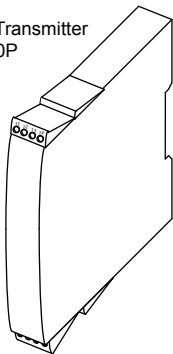

A CJC Connector  
or an RTD Connector

F0301.ai

Figure 3.1 Part Names

## 4. Installation

For details of choosing the installation location, refer to the guidelines outlined in Section 2.4, “Choosing the installation location”.

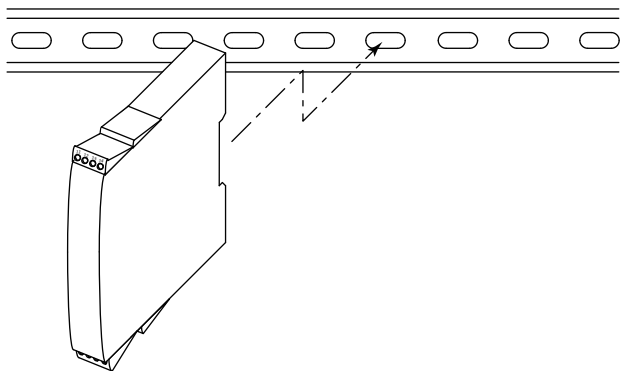

Mounting on DIN rail

F0401.ai

**Figure 4.1** Mounting the Transmitter

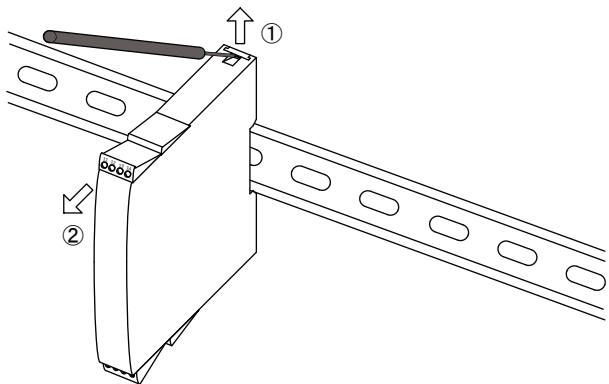

First, remember to turn off power supply and remove output signal cable. Detach the device from the DIN rail by lifting the lock.

F0402.ai

**Figure 4.2 Detach the Transmitter**

## 5. Wiring

### 5.1 Notes on Wiring



#### IMPORTANT

- Lay wiring as far away as possible from electrical noise sources such as large transformers, motors and power supplies.
- To prevent electrical noise, the signal cable and the power cable must not be housed in the same conduit.

### 5.2 Loop Construction

The YTA70P is a two-wire temperature transmitter that uses the output power supply wiring and signal wiring alternately.

The transmission loop requires DC power. Connect the transmitter with the distributor as shown in Figure 5.1 or Figure 5.2.

For the transmission loop, the load resistance of the distributor or other instrument to be installed in the loop and the lead wire must be within the range shown in Figure 5.3.

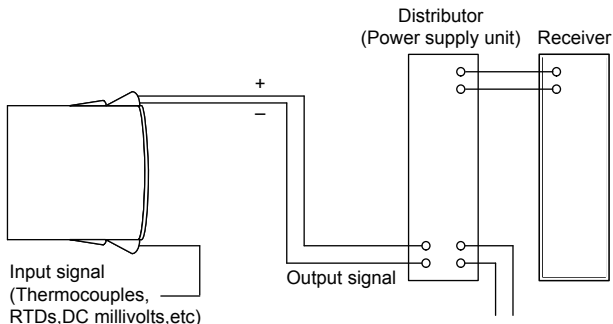

F0501.ai

Figure 5.1 Loop Construction (for General-use Type)

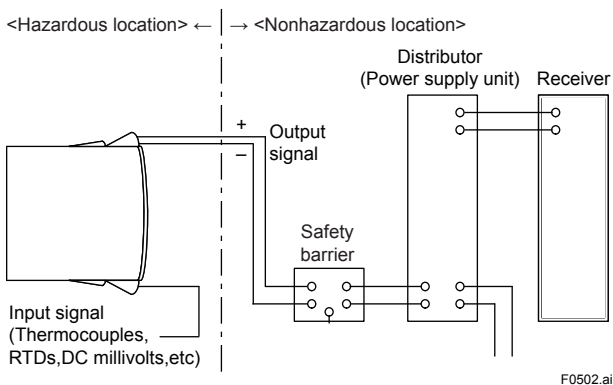

F0502.ai

**Figure 5.2 Loop Construction (for Intrinsically Safe Type)**

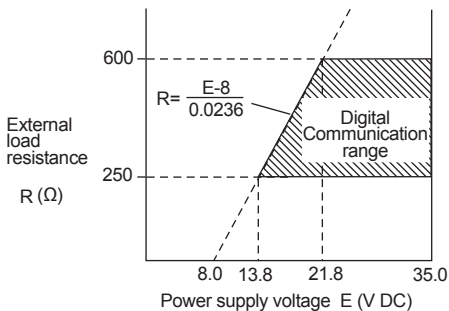

F0503.ai

**Figure 5.3 Relation between Power Supply Voltage and Load Resistance**

Note: For intrinsic safe explosion protected type units, the internal resistance of the safety barrier is also included in the load resistance.

## 5.3 Cable Selection

### 5.3.1 Input signal Cable Selection

A dedicated cable is used for connection between the temperature sensor and the temperature transmitter.

When a thermocouple is used as the temperature sensor, a compensation wire which is appropriate for the type of thermocouple must be used (refer to compensating cables for IEC584 thermocouples). When a resistance temperature sensor (RTD) is used as the temperature sensor, 2-core/3-core/4-core cable must be used (refer to resistance thermometer sensor IEC751).

### 5.3.2 Output Signal Cable Selection

- Use cables of 0.13 to 2.08 mm<sup>2</sup> / AWG26 to 14.
- For wiring in areas susceptible to electrical noise, use shielded wires.
- For wiring in high or low temperature areas, use wires or cables suitable for such temperatures.
- For use in an atmosphere where harmful gases or liquids, oil, or solvents are present, use wires or cables made of materials resistant to those substances.

## 5.4 Cable and Terminal Connections

### Wiring Diagram

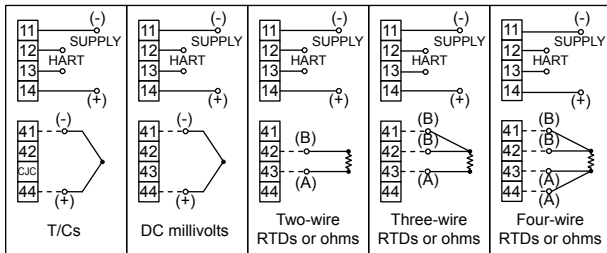

F0504.ai

Figure 5.4 YTA70P Wiring Diagram

## 6. Maintenance

### 6.1 General

Each component of this instrument is configured in units to make maintenance easier.

This chapter contains trim adjustment and troubleshooting for maintenance of the affected instrument.



### **IMPORTANT**

---

Maintenance of this instrument should be performed in a service shop where the necessary tools are provided.

---

### 6.2 Trim adjustment

This instrument is fully factory-tested and is guaranteed for the intended accuracy, eliminating the need for the trim adjustment. When the trim adjustment needs, the following procedure is recommended.

#### 6.2.1 Trim Procedure

##### 1. Trim sensor

The sensor trim procedure allows you to adjust for local conditions, changing how the transmitter calculates process variables. There are two ways to trim the sensor: Device variable zero trim and Device variable trim. Device variable zero trim is a one-point adjustment typically used to compensate for zero shifts. Device variable trim is a two-point process, in which two accurate end-point sensor input are applied (equal to or greater than the range values), and all output is linearized between them.

- Procedure to call up the D/A trim display

Device setup → Diag/Service → Calibration → Dev var zero trim

Device variable trim

In Device variable trim, if the output value is different from the trim setting value, repeat device variable trim procedure.



a. Example of wiring for thermocouples or DC millivolts input

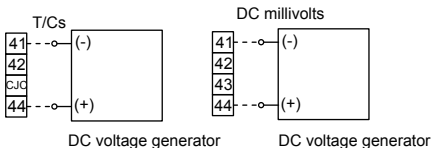

b. Example of wiring for thermometer resistor 4-core type

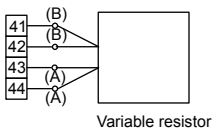

F0601.ai

**Figure 6.1 Example of Wiring for Trim sensor**

## 2. Trim Analog Output

Fine current output adjustment is carried out with D/A trim. D/A trim is to be carried out if the calibration digital meter does not exactly read 4.000 mA and 20.000 mA with an output signal of 0% and 100%.

- Procedure to call up the D/A trim display

Device setup → Diag/Service → Calibration → D/A trim

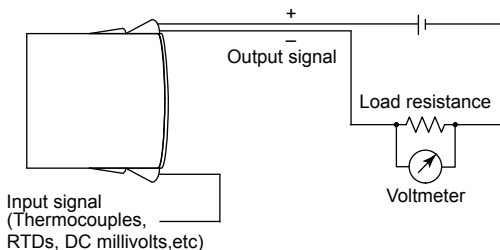

F0602.ai

**Figure 6.2 Example of Wiring for analog trim**

## 6.3 Troubleshooting

When the measured value is found abnormal, follow the troubleshooting flowchart below.

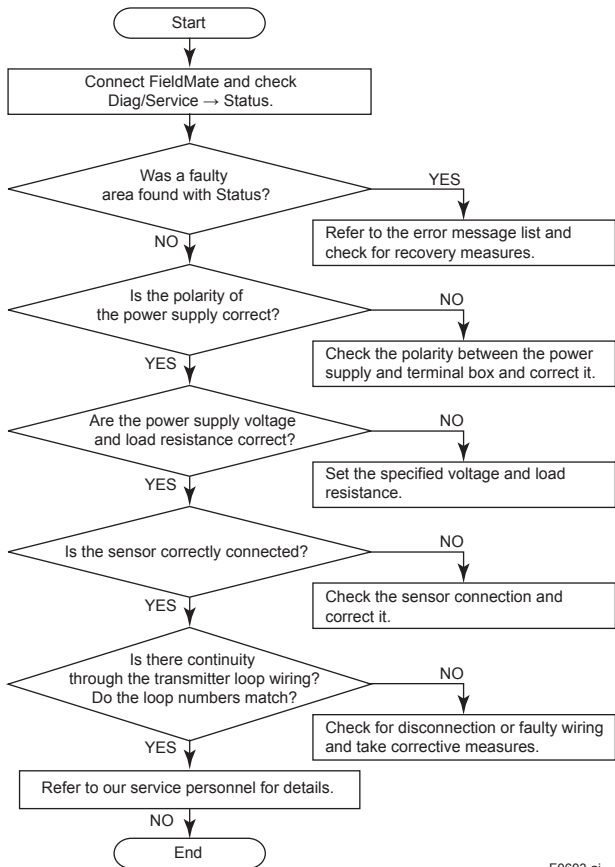

## Alarms and Countermeasures

Diag/Service → Status		Cause	Action
Sensor errors	Sensor1 (Fld dev stat0-1)	Sensor1 error is detected.	1. Check Sensor1 for damage. 2. Check terminal connection. 3. Check cable resistance value setting. Set double of the cable resistance between the sensor and the device. It is necessary for 2-wire, 3-wire and 4-wire RTDs/ohms to compensate cable resistance.
	Sensor2 (Fld dev stat0-2)	Future use	N/A
	CJC/electronics sensor (Fld dev stat0-3)	CJC failure is detected.	Use CJC connector for thermocouple measurement.
ADC errors	ADC communication (Fld dev stat1-1)	ADC failure is detected.	Contact our service.
	ADC checksum (Fld dev stat1-3)		
	ADC timeout (Fld dev stat1-4)		
Misc. errors	EEPROM readback (Fld dev stat2-1)	EEPROM failure is detected.	Contact our service.
	EEPROM integrity (Fld dev stat2-2)		
	RAM integrity (Fld dev stat2-3)	RAM failure is detected.	
	ADC initialization (Fld dev stat2-4)	ADC failure is detected.	
	Flash integrity (Fld dev stat2-6)	Flash ROM failure is detected.	
	Software (Fld dev stat2-7)	Software failure is detected.	

Diag/Service → Status		Cause	Action
Ext device status	Maintenance required	This bit is set when a sensor error is detected by the device.	1. Check Sensor1 for damage. 2. Check terminal connection.
	Device variable alert	This bit is set if any of the device variables are out of limits. This bit is set when any of the device status bits "PV Values of Of Limits".	Check PV range.
	Critical power failure	Future use	N/A
Device Diagnostic Status 0	Simulation active	Future use	N/A
	Non-volatile memory failure	EEPROM failure is detected.	Contact our service.
	Volatile memory error	RAM failure is detected.	
	Watchdog reset executed	Software failure is detected.	
	Voltage conditions out of range	The power supply voltage is outside its allowable range.	Check power supply voltage.
	Environmental conditions out of range	Environmental condition is beyond acceptable limits.	Check ambient temperature. Take enough distance from heat source. Or use the heater to raise ambient temperature.
	Electric failure	Hardware failure is detected.	Contact our service.

## 7. General Specifications

### 7.1 Standard Specifications

#### Accuracy

See Table 7.1.

#### Cold Junction Compensation Accuracy (For T/Cs only)

$\pm 1^{\circ}\text{C}$  ( $\pm 1.8^{\circ}\text{F}$ )

#### Ambient Temperature Effects

See Table 7.1.

#### Power Supply Effects

$\pm 0.005\%$  of FS per Volt

#### EMC Conformity

CE: EN61326-1, EN61326-2-3, EN 55011

KC: Korea Electromagnetic Conformity standard. Class A

RCM: EN61326-1, EN 55011

#### RoHS conformity

EN50581

#### Input Type, Span and Range

Selection from thermocouples (T/Cs), 2-, 3-, and 4- wire RTDs, ohms and DC millivolts. See Table 7.1.

#### Maximum Zero offset

$\pm 50\%$  of selected maximum value

#### Input Resistance (for thermocouples, mV)

10 M $\Omega$ , or 3 k $\Omega$  at power-off

#### Input Lead Wire Resistance (for RTDs, ohms)

5  $\Omega$  per wire or lower

(up to 50  $\Omega$  per wire is configurable with reduced measurement accuracy)

#### Sensor Burnout

High(NAMUR NE43 upscale) , Low(NAMUR NE43 downscale) or value within 3.5 to 23 mA

#### Output

Two wire 4 to 20 mA DC

**Response Time\*1**

1 to 60 seconds programmable

\*1: Response time =  $2.3026 \times$  Damping time

**Ambient Temperature Limits (Option code may affects limit)**

-40 to 60°C (-40 to 140°F)

**Ambient humidity limits**

0% to 95% RH (non-condensation)

**Isolation**

Input/output isolated to 1500 V AC.

Supply & Load Requirements

**Voltage**

8 to 35 V DC for operation (8 to 30 V DC for Intrinsically safe type)

13.8 to 35 V DC for digital communication

**Load Resistance**

0 to  $(E-8)/0.0236$  [ $\Omega$ ]

where E is power supply voltage.

250 to 600  $\Omega$  for digital communication

See Figure 5.3.

**Enclosure Material**

Polycarbonate

**Mounting**

DIN rail: DIN EN 60715 - 35mm

**Wire size**

0.13...2.08 mm<sup>2</sup> / AWG26...14 stranded wire

**Weight**

150 g (0.33 lb)

Table 7.1 Input type, range and accuracy

Sensor type	Standard	Input ranges		Minimum span		Accuracy (value whichever is greater)	Temp. effects/10°C (value whichever is greater)
		°C	°F	°C	°F		
<T/Cs>							
B	IEC584	400 to 1820	752 to 3308	200	360	±0.1% of span or ±1.0°C	±0.05% of span or ±1.0°C
E		-100 to 1000	-148 to 1832	50	90	±0.1% of span or ±0.5°C	±0.05% of span or ±0.25°C
J		-100 to 1200	-148 to 2192	50	90		
K		-180 to 1372	-292 to 2502	50	90		
N		-180 to 1300	-292 to 2372	100	180		
R		-50 to 1760	-58 to 3200	200	360	±0.1% of span or ±1.0°C	±0.05% of span or ±1.0°C
S		-50 to 1760	-58 to 3200	200	360		
T		-200 to 400	-328 to 752	50	90	±0.1% of span or ±0.5°C	±0.05% of span or ±0.25°C
L	DIN43710	-100 to 900	-148 to 1652	50	90		
U		-200 to 600	-328 to 1112	75	135		
Lr	GOST 3044-84	-200 to 800	-328 to 1472	50	90	±0.1% of span or ±1.0°C	±0.05% of span or ±1.0°C
W3	ASTM	0 to 2300	32 to 4172	200	360		
W5	E988-90	0 to 2300	32 to 4172	200	360		
<RTDs>							
PT100	IEC751	-200 to 850	-328 to 1562	10	18	±0.1% of span or ±0.1°C	±0.05% of span or ±0.05°C
NI100	DIN43760	-60 to 250	-76 to 482	10	18	±0.1% of span or ±0.2°C	
DC millivolts [mV]		-800 to 800 [mV]		2.5 [mV]		±0.1% of span or ±0.01mV	±0.05% of span or ±5µV
Resistance [Ω]		0 to 7000 [Ω]		25 [Ω]		±0.1% of span or ±0.1Ω	±0.05% of span or ±0.05Ω

Note: In T/Cs type B, the minimum range value can be set from 0°C. However the accuracy between 0 to 400°C is not specified.

Model YTA70P will be shipped with the following settings from the factory if not specified upon ordering;

**Table 7.2 Factory setting**

Items	Default value
Sensor Type Settings	Pt100, 3-wire
Lower input Range Setting	0
Upper input Range Setting	100
Unit of Input Range Setting	degC
Sensor Burn-out Settings	NAMUR up (Up scale 23.0mA)
Response time	1s (1 second)

## 7.2 Model and Suffix Codes

Model	Suffix Codes	Descriptions
YTA70P	.....	Temperature Transmitter (Panel Mount Type)
Output Signal	~J .....	4 to 20 mA DC with digital communication (HART 7 protocol)
—	A .....	Always A
Optional Specifications	/V2S ...	ATEX, FM, IECEx, and CSA Intrinsically safe Approval

## 7.3 Optional Specifications

### ATEX, FM, IECEx, and CSA Intrinsically safe Approval

ATEX Intrinsically safe Approval

Applicable Standards: EN 60079-0:2012, EN 60079-11:2012,  
EN 60079-26:2007

Certificate: DEKRA 14ATEX0106 X

II 1 G Ex ia IIC T5 Ga Degree of protection: IP20 Amb. Temp.: -40 to 60°C

II 1 D Ex ia IIIC Da Degree of protection: IP6X Amb. Temp.: -40 to 85°C

Supply and output circuit:  $U_i=30V$ ,  $I_i=120mA$ ,  $P_i=0.84W$ ,  $C_i=1nF$ ,  $L_i=10\mu H$

Sensor circuit:  $U_o=9.6V$ ,  $I_o=28mA$ ,  $P_o=67.2mW$ ,  $C_o=3.5\mu F$ ,  $L_o=35mH$



### FM Intrinsically safe Approval

Applicable Standards: Class 3600, Class 3610, Class 3611, Class 3810,  
ANSI/ISA-60079-0, ANSI/ISA-60079-11

Intrinsically Safe for Class I, Division 1, Groups A, B, C & D

Class I, Zone 0, AEx ia, Group IIC, T6

Amb. Temp.: -40 to 60°C

Entity Parameters: V Max=30V, I Max=120mA, Pi=0.84W, Ci=1nF,  
Li=10μH, Vt=9.6V, It=28mA, Po=67.2mW, Ca=3.5μF, La=35mH

### IECEX Intrinsically safe Approval

Applicable Standards: IEC 60079-0: 2011, IEC 60079-11:2011,  
IEC 60079-26:2006

Certificate: IECEX DEK 14.0058X

Ex ia IIC T5 Ga Enclosure: IP20 Amb. Temp.: -40 to 60°C

Ex ia IIIC Da Enclosure: IP6X Amb. Temp.: -40 to 85°C

Supply and output circuit: Ui=30V, Ii=120mA, Pi=0.84W, Ci=1nF, Li=10μH

Sensor circuit: Uo=9.6V, Io=28mA, Po=67.2mW, Co=3.5μF, Lo=35mH

### CSA Intrinsically safe Approval

Certificate: 70009864

Applicable Standards:

CAN/CSA-C22.2 No.0-10, CSA Std C22.2 No.142-M1987 (R2009),  
CSA Std C22.2 No.157-92(R2012), CAN/CSA-C22.2 No.60079-0:11,  
CAN/CSA- C22.2 E60079-11:11,

Class I, Division 1, Groups A, B, C & D, Ex ia IIC, Ga

UL Std No. 913 Ed. 8 , UL Std No. 916 Ed. 4, UL 60079-0 Ed 5,

UL Std No. 60079-11 Ed. 6

Class I, Division 1, Groups A, B, C & D

Class I, Zone 0, AEx ia IIC, Ga

Temperature Class: T6

Amb. Temp.: -40 to 60 °C

Input entity parameters: Ui(Vmax)=30V, Ii(I max)=120mA, Pi=0.84W,  
Ci=1nF, Li=10μH

Output entity parameters: Uo(Uoc)=9.6V, Io(Isc)=28mA,  
Po(Pmax)=67.2mW, Co(Ca)=3.5μF, Lo(La)=35mH

## 7.4 Dimensions

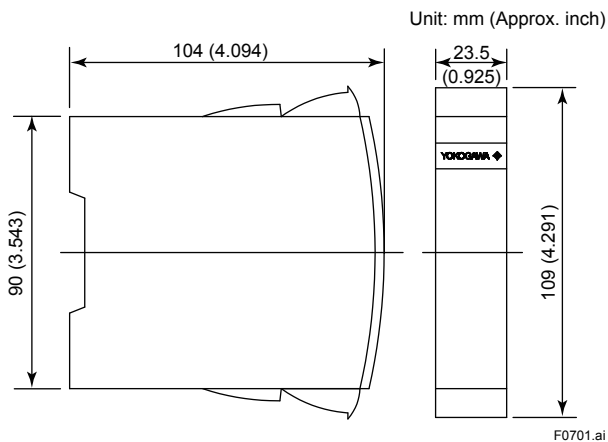

## 8. HART Communicator Operation

### 8.1 Connection and Requirements

A standard HART communicator can be used for programming the YTA70P. The HART communicator must be loaded with the appropriate DDL driver for YTA70P.

Minimum loop resistance is 250  $\Omega$ . If the receiving equipment has a lower resistance, a serial resistor must be inserted to communicate with the HART communicator.

#### [Connection]

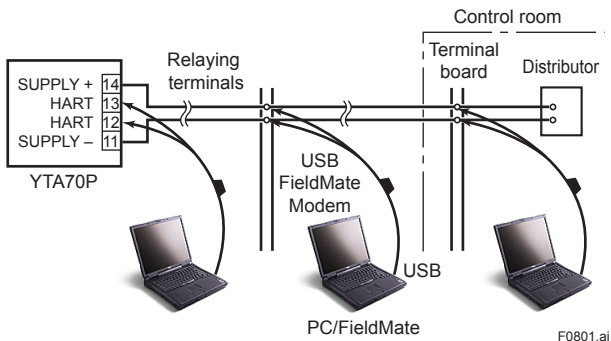
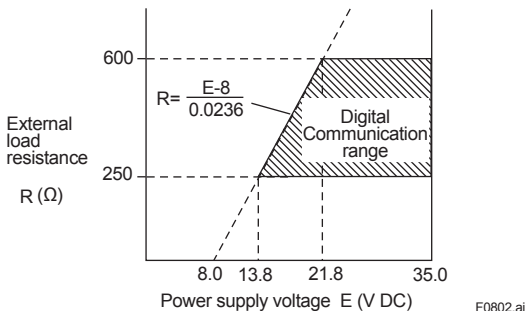

Figure 8.1 Connecting the HART configuration Tool

**[Communication requirement]**

**Figure 8.2 Relationship between Power Supply Voltage and External Load Resistance**

Note: For intrinsic safe explosion protected type units, the internal resistance of the safety barrier is also included in the load resistance.

## 8.2 Parameters

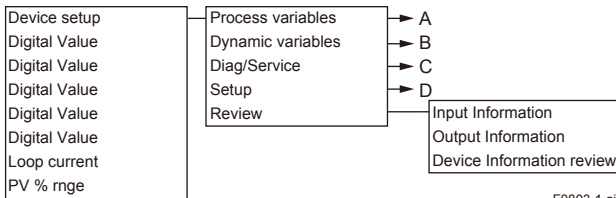

F0803-1.ai

**A**

Process variables

Digital Value (Sensor1)  
Limit status  
Data Quality  
Digital Value (Sensor2)  
Limit status  
Data Quality  
Digital Value (CJC)  
Limit status  
Data Quality  
Digital Value (Average)  
Limit status  
Data Quality  
Digital Value (Difference)  
Limit status  
Data Quality  
Loop current  
PV % rng

F0803-2.ai

**B**

Dynamic variables

Digital Value (PV)  
Limit status  
Data Quality  
Digital Value (SV)  
Limit status  
Data Quality  
Digital Value (TV)  
Limit status  
Data Quality  
Digital Value (FV)  
Limit status  
Data Quality  
Loop current  
PV % rng

F0803-3.ai

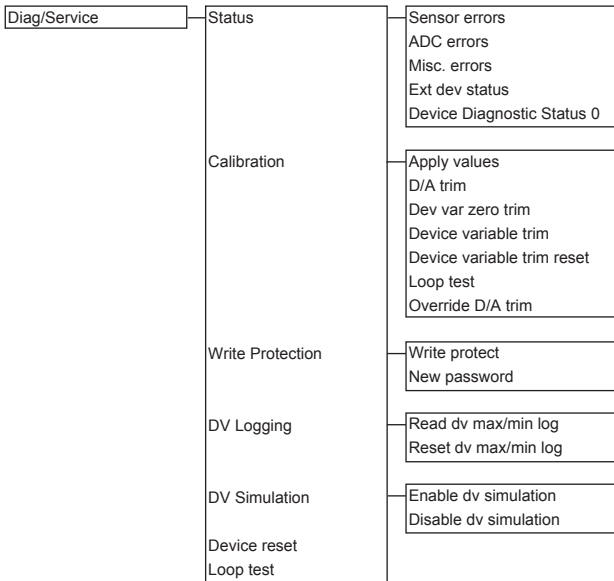
**C**

F0803-4.ai

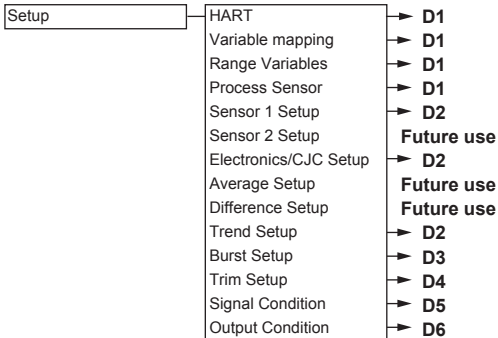
**D**

F0803-5.ai

## D1

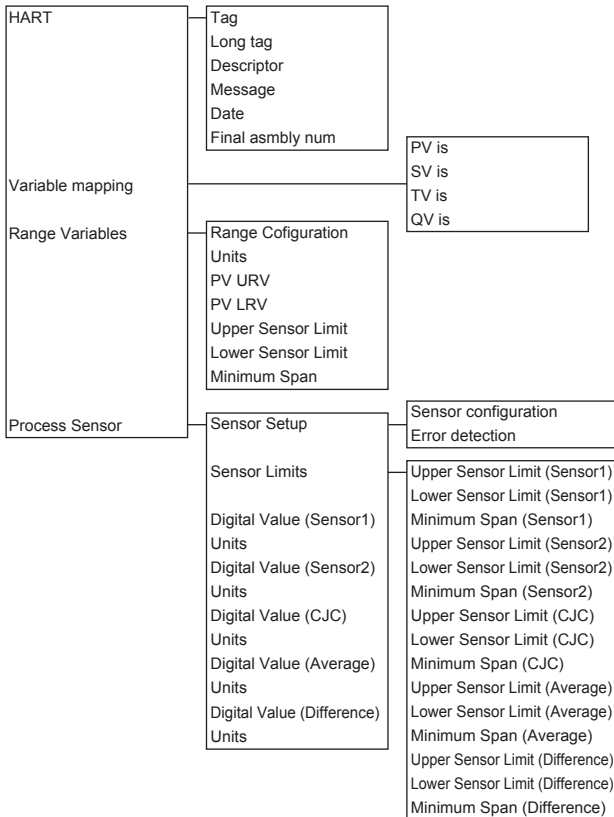

F0803-6.ai

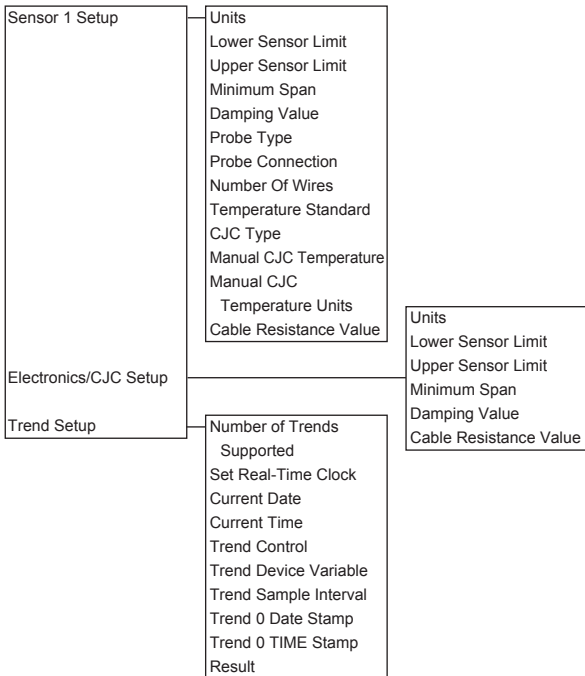

**D2**

F0803-7.ai

## D3

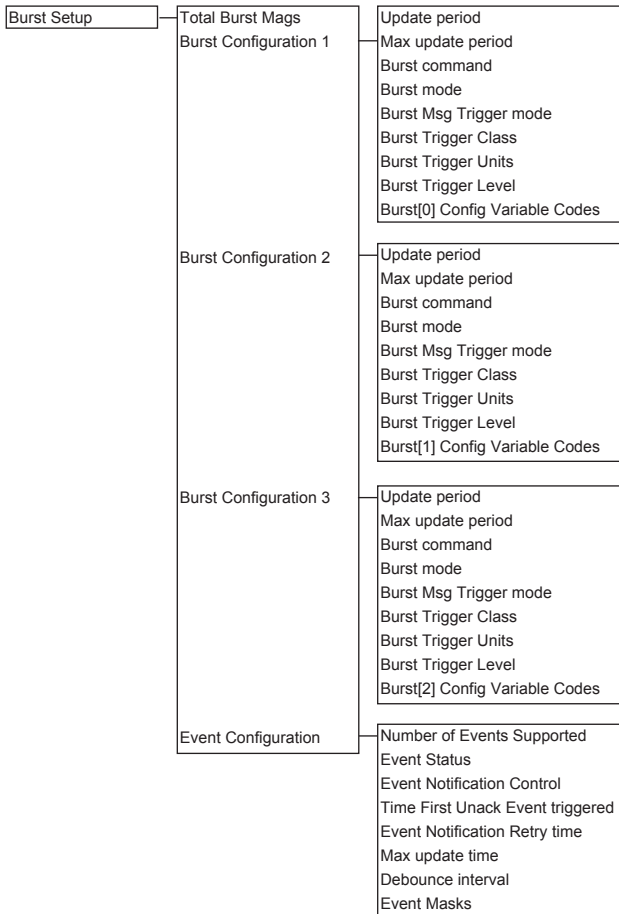

F0803-8.ai

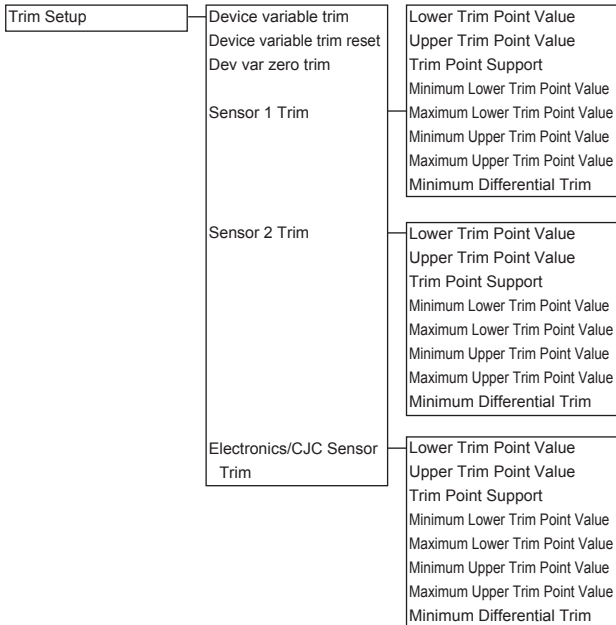
**D4**

F0803-9.ai

**D5**

Signal Condition

Lower Sensor Limit (Sensor1)  
Upper Sensor Limit (Sensor1)  
Units (Sensor1)  
Damping Value (Sensor1)  
Lower Sensor Limit (Sensor2)  
Upper Sensor Limit (Sensor2)  
Units (Sensor2)  
Damping Value (Sensor2)  
Lower Sensor Limit (CJC)  
Upper Sensor Limit (CJC)  
Units (CJC)  
Damping Value (CJC)  
Lower Sensor Limit (Average)  
Upper Sensor Limit (Average)  
Units (Average)  
Damping Value (Average)  
Lower Sensor Limit (Difference)  
Upper Sensor Limit (Difference)  
Units (Difference)  
Damping Value (Difference)

F0803-10.ai

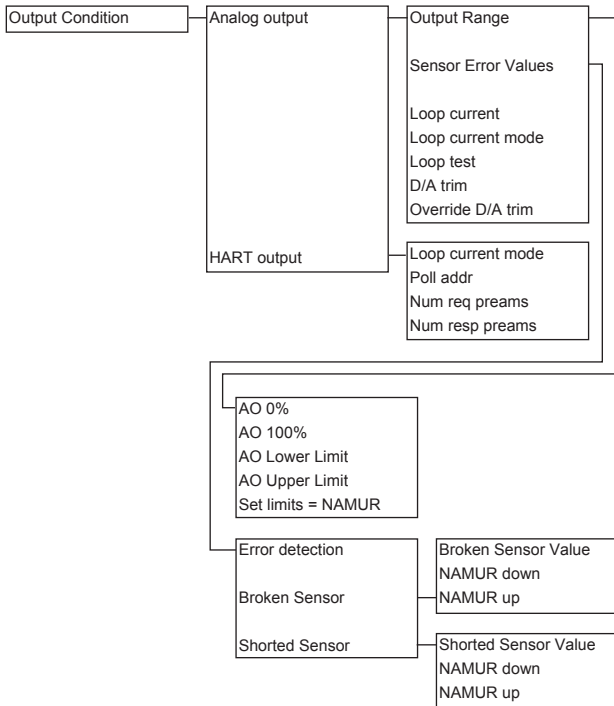
**D6**

F0803-11.ai

### 8.3 Device Variables Mapping

There are two device variables available.

- 1) Sensor
- 2) CJC

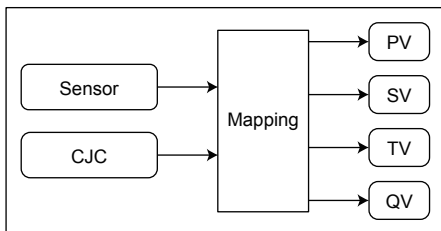

F0804.ai

## Burst Parameters

Command Parameter	Burst Command	Burst Msg Trigger Mode	Burst Trigger Source	Burst Trigger Units
PV Temperature value assigned to PV	Cmd1: PV	Continuous Window Rising Falling On-change	-	-
			PV	Depend on PV assignment
% range/Loop current	Cmd2: % range/Current	Continuous Window Rising Falling On-change	-	-
			% range	%
Process variables/Loop current	Cmd3: Dyanamic variables/Current	Continuous Window Rising Falling On-change	-	-
			PV	Depend on PV assignment
Process vars/% range/Loop current with status	Cmd9: Device variables with status	Continuous Window Rising Falling On-change	-	-
			Sensor, EI/CJC, PV, SV, TV, QV(*1)	Depend on burst trigger source
Process vars/% range/Loop Current	Cmd33: Device variables	Continuous Window Rising Falling On-change	-	-
			Sensor, EI/CJC, PV, SV, TV, QV(*1)	Depend on burst trigger source
Self diagnosis information	Cmd48: Additional device status	Continuous	-	-

(\*1) Loop current and % range are selectable from menu but not available.

## 8.4 Parameter List

Item		Parameter name	Descriptions	Initial setting
Process variables		Digital Value	Device variable value in engineering unit (Sensor2, Average and Difference is for future use)	N/A
		Limit status	Data quality and limit status	N/A
		Data Quality	of device variables	N/A
		Loop current	Output value in mA	N/A
		PV % mge	Output value with respect to the range in %	N/A
Dynamic variables		Digital value (PV/SV/TV/QV)	Dynamic variables	N/A
		Limit status	Data quality and limit status	N/A
		Data Quality	of PV/SV/TV/QV	N/A
		Loop current	Output value in mA	N/A
		PV % mge	Output value with respect to the range in %	N/A
Diag/ Service	Status	Sensor errors	Show error status related to a sensor. When any one of the errors turns "ON", check the sensor and wiring	N/A
		ADC errors	Show error status related to analog to digital conversion. When any one of the errors turns "ON", restart the device. If error remains, replace the device	N/A
		Misc. errors	Show error status related to a device. When any one of the errors turns "ON", restart the device. If error remains, replace the device.	N/A
		Ext device status	This bit is set if any Device Variable is in an Alarm or Warning State	N/A
		Device Diagnostic Status 0	Device status of diagnostic	N/A



Item	Parameter name	Descriptions	Initial setting	
Diag/ Service	Calibration	Apply values	Rerange by actual input	N/A
		D/A trim	Allows the calibration of a selected analog output with an external reference at the operating endpoint	N/A
		Dev var zero trim	Sensor and CJC ZeroTrimming	N/A
		Device variable trim	Sensor and CJC Trimming. If the output value is different from the trim setting value, repeat device variable trim procedure.	N/A
		Device variable trim reset	Reset sensor trim for factory setting	N/A
		Loop test	Change the output manually for testing the loop. 4mA, 20mA, or value within 3.5 to 23mA	N/A
		Override D/A trim <Clear D/A trim>	Overrides any previous D/A trimming by restoring factory calibration values	N/A
Write Protection	Write protect	Sets a password to disable write protection	N/A	
	New password	New password setting	N/A	
DV logging	Read dev var max/min log	Reads the maximum/minimum PV stored in the memory	N/A	
	Reset dev var max/min log	Clears the PV maximum/minimum log and restart logging	N/A	
DV Simulation	Enable DV simulation	Execution of device variable simulation	N/A	
	Disable DV simulation			
Device reset <Master reset>		Software reset	N/A	
Loop test		Change the output manually for testing the loop. 4mA, 20mA, or value within 3.5 to 23mA	N/A	

Item	Parameter name	Descriptions	Initial setting
Setup	HART	Tag Tag number, up to 8 alphanumeric characters	N/A
	Long Tag	Tag number, up to 32 alphanumeric characters.	N/A
	Descriptor	Text which can be used by user in any way. Up to 16 alphanumeric characters	N/A
	Message	Text which can be used by user in any way. Up to 32 alphanumeric characters	N/A
	Date	Date information. MM/DD/YY. Not incremented. The date is updated whenever changing onfiguration via configuration tool	N/A
	Final assembly num	Assembly number	N/A
Variable mapping	PV is/SV is/TV is/FV is	Setting an assignment for PV/SV/TV/QV	PV=Sensor, SV=EI/CJC, TV=QV=None
Range Variables	Range configuration	Range setting for PV LRV/ PV URV	*1
	Units	Unit of PV	*1
	PV LRV/PV URV	Lower/upper range value to defines the 0%/100% value of the measurement	Depend on range configuration
	Apply values	Rerange by actual input	N/A
	Upper Sensor Limit/Lower Sensor Limit	Maximum/minimum values for range setting	Depend on sensor setup
	Minimum Span	PV minimum span	
Process Sensor → Sensor Setup	Sensor configuration	Sensor type and related settings.	*1
	Error detection	Type of sensor errors to be detected for burnout operation	broken and shorted sensor
Process Sensor → Sensor Limits	Upper Sensor Limit/Lower Sensor Limit	Maximum/minimum values for the sensor	Depend on sensor setup
	Minimum Span	Minimum span of the sensor	

Item	Parameter name	Descriptions	Initial setting	
Setup	Process Sensor	Units	Sensor1 unit setting	degC
	→ Sensor1 Setup	Lower Sensor Limit/Upper Sensor Limit	Maximum/minimum values of Sensor1	Depend on sensor setup
		Minimum Span	Minimum span of Sensor1	
	Damping Value	Damping time constant in seconds: 0.4 to 60.0s	*1	
	Probe Type	Sensor type setting.	*1	
	Probe Connection	Single	N/A	
	Number of Wires	Setting the number of sensor connection wires	*1	
	Temperature Standard	International Temperature Scale of 1990 (ITS-90)	N/A	
	CJC Type	Selecting of Internal CJC or Fixed CJC	Internal sensor	
	Manual CJC Temperature	Fixed CJC value setting	N/A	
	Manual CJC Temperature Units	Unit of Fixed CJC value setting	N/A	
	Cable Resistance Value	Resistance of sensor cable setting Set double of the cable resistance between the sensor and the device. It is necessary for 2-wire, 3-wire and 4-wire RTDs/ ohms to compensate cable resistance	5.0Ω	
	Setup	Process Sensor	Units	Unit of CJC setting
→ Electronics/ CJC Setup		Lower Sensor Limit/Upper Sensor Limit	Maximum/minimum values of CJC	N/A
		Minimum Span	CJC minimum span	N/A
Damping Value		Damping time constant in seconds: 0.4 to 60.0s	0.4	
Cable Resistance Value		CJC cable resistance	0Ω	

Item	Parameter name	Descriptions	Initial setting
Setup	Sensor2 Setup/Average Setup/Difference Setup	All parameters	Future use
	Trend Setup	Number of Trends Supported	Data trending support function
		Set Real-Time Clock	Setting for date and time of clock.
		Current Date	Date and Time of clock
		Current Time	N/A
		Trend Control	Trend data setting
		Trend Device Variable	Device variable value selecting for Trend data
		Trend Sample Interval	Sampling interval of Trend data
		Trend 0 Date Stamp	Date and Time information of latest Trend data
		Trend 0 TIME Stamp	N/A
		Result	Result of Trend data
Burst mode	Total burst msgs	The number of burst mode functions	N/A
	Update period	Update period for burst message	N/A
	Max update period	Maximum update period for burst message	N/A
	Burst command	Setting for burst command	N/A
	Burst mode	Setting for burst mode	Off
	Burst Msg Trigger mode	Burst trigger mode selection from "Continuous", "Window", "Rising", "Falling", or "On change"	N/A
	Burst Trigger Class	Device variable not classified	N/A
	Burst Trigger Units	Setting for unit of burst trigger level	N/A
	Burst Trigger Level	Setting for burst trigger level	N/A

Item		Parameter name	Descriptions	Initial setting
Setup	Burst mode	Burst variable code	Setting for device variable of cmd9 or cmd33	N/A
	Event notification	Number of Events supported	Maximum number of event support	N/A
		Event status	Display event status	N/A
		Event Notification control	Enable event notification on token-passing data link layer	Off
		Time First Unack Event triggered	Display event time	N/A
		Event Notification Retry time	Event notification retry time	N/A
		Max update time	Maximum update time for event notification	N/A
		Debounce interval	Debounce Interval to detect an event	N/A
		Event mask	Event masking	N/A
	Trim Setup	Device variable trim	Sensor and CJC Trimming. If the output value is different from the trim setting value, repeat device variable trim procedure.	N/A
		Device variable trim reset	Reset sensor trim for factory setting	N/A
		Dev var zero trim	Sensor and CJC Zero Trimming	N/A
		Lower Trim Point Value/ Upper Trim Point Value	Lower and Upper trimming point	N/A
		Trim Point Support	Lower and upper trim point supported	N/A

Item		Parameter name	Descriptions	Initial setting
Setup	Trim Setup	Minimum Lower Trim Point Value /Maximum Lower Trim Point Value /Minimum Upper Trim Point Value /Maximum Upper Trim Point Value	Maximum/minimum values for trimming point	N/A
		Minimum Differential Trim	Minimum value of the difference of lower and upper trimming point	N/A
	Signal Condition	Upper Sensor Limit/Lower Sensor Limit	Maximum/minimum values for device variables range	Depend on sensor setup
		Units	Device variables unit	degC
		Damping Value	Damping time constant in seconds: 0.4 to 60.0s	*1
Output Condition → Analog output		Loop current <PV AO>	Output value in mA	N/A
		Loop current mode	Loop current setting at multidrop	Off
		Loop test	Change the output manually for testing the loop. 4mA, 20mA, or value within 3.5 to 23mA	N/A
		D/A trim	Allows the calibration of a selected analog output with an external reference at the operating endpoint	N/A
		Override D/A trim <Clear D/A trim>	Overrides any previous D/A trimming by restoring factory calibration values	N/A
Output Condition → Analog output → Output range		AO 0%(100%)	Output value for 0% (100%) in mA.	4mA (20mA)
		AO lower(upper) Limit	Output lower (upper) limit in mA. NAMUR, or 3.8 to 23mA	3.8mA (20.5mA)

Item		Parameter name	Descriptions	Initial setting	
Setup	Output Condition → Analog output → Output range	Set limit = NAMUR	Setting for loop cur lower limit = 3.8mA, loop cur upper limit = 20.5mA	N/A	
	Output Condition → Analog output → Sensor Error Values	Error detection	Type of sensor errors to be detected for burnout operation. (1)No test performed, (2)broken sensor, (3)shorted sensor, or (4)broken & shorted.	broken and shorted sensor	
		Broken Sensor value	Setting for analog output value when sensor broken	*1	
		Shorted Sensor value	Setting for analog output value when sensor shorted	3.6mA	
		NAMUR down	Set analog output value to 3.5mA when sensor broken or shorted	N/A	
		NAMUR up	Set analog output value to 23mA when sensor broken or shorted	N/A	
	Output Condition → HART output	Loop current mode	Loop current setting at multidrop	Off	
		Poll addr	Display and setting for multidrop (0 to 63)	0	
		Num req preams	Number of requested preambles	N/A	
		Num resp preams	Number of response preambles	5	
	Review	Input Information		List of input variables	N/A
		Output Information		List of output variables	N/A
Device Information review			List of device information	N/A	

\*1: As specified in the order. If not specified, refer to Table 7.2.

# Appendix1. ATEX Installation drawing YTA70PQA01

## ATEX

### Installation drawing YTA70PQA01



For safe installation of the YTA70P-JA/V2S and YTA70P-JB/V2S the following must be observed. The module shall only be installed by qualified personnel who are familiar with the national and international laws, directives and standards that apply to this area.

ATEX Certificate DEKRA 14 ATEX0106X

Marking  II 1 G Ex ia IIC T5 Ga  
II 1 D Ex ia IIIC Da

Standards EN60079-0:2012, EN60079-11:2012, EN60079-26:2007

Hazardous area  
Zone 0, 1, 2, 20, 21, 22

T5:  $-40 \leq T_a \leq 60^\circ\text{C}$

Non Hazardous Area

**Terminal:**  
**41,42,43,44**  
Uo: 9.6 VDC  
Io: 28 mA  
Po: 67.2 mW  
Lo: 35 mH  
Co: 3.5  $\mu\text{F}$

**Terminal:**  
**51,52,53,54**  
Uo: 9.6 VDC  
Io: 28 mA  
Po: 67.2 mW  
Lo: 35 mH  
Co: 3.5  $\mu\text{F}$

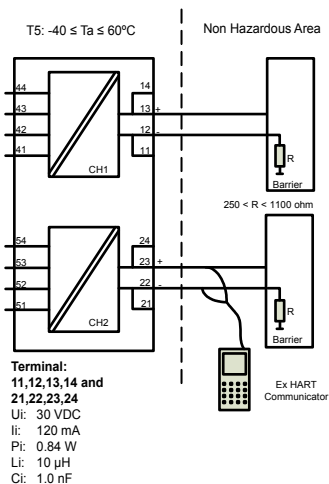



---

## ATEX

### Installation drawing YTA70PQA01

---

#### General installation instructions

To avoid risk of ignition during installation and maintenance appropriate safety measures against electrostatic discharge (ESD) are to be considered.

The sensor circuit is not infallibly galvanic isolated from the supply output circuit. However, the galvanic isolation between the circuits is capable of withstanding a test voltage of 500Vac during 1 minute.

#### For installation in a potentially explosive gas atmosphere the following instructions apply:

To avoid risk of ignition due to electrostatic discharge (ESD) the transmitter shall be mounted in an enclosure providing a degree of protection of at least IP20 according to EN/IEC 60529.

Ambient temperature range:

T5:  $-40 \leq Ta \leq 60^{\circ}\text{C}$

#### For installation in a potentially explosive dust atmosphere, the following instructions apply:

The transmitter shall be mounted in a metal enclosure or equivalent that is providing a degree of protection of at least IP6X according to EN/IEC 60529 that is suitable for the application and correctly installed. Cable entries and blanking elements shall be used that are suitable for the application and correctly installed. The surface temperature of the enclosure is equal to the ambient temperature +20K for a dust layer with a maximum thickness of 5 mm.

Ambient temperature range:

T5:  $-40 \leq Ta \leq 60^{\circ}\text{C}$

# Appendix2. FM Installation drawing YTA70PQF01

## FM

### Installation drawing YTA70PQF01

Hazardous (Classified) Location  
Class I, Division 1, Group A,B,C,D T6 T6:  $-40 \leq T_a \leq 60^\circ\text{C}$   
Class I, Zone 0, AEX ia IIC T6

Non Hazardous Location

**Terminal:**

**41,42,43,44**

Uo: 9.6 VDC

Io: 28 mA

Po: 67.2 mW

Lo: 35 mH

Co: 3.5 $\mu$ F

**Terminal:**

**51,52,53,54**

Uo: 9.6 VDC

Io: 28 mA

Po: 67.2 mW

Lo: 35 mH

Co: 3.5 $\mu$ F

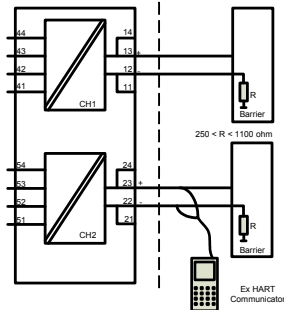

**Terminal:**

**11,12,13,14 and  
21,22,23,24**

Ui: 30 VDC

Ii: 120 mA

Pi: 0.84 W

Li: 10  $\mu$ H

Ci: 1.0 nF

Ex HART  
Communicator

#### Installation notes.

For installation in Class I the Transmitter must be installed in a suitable enclosure to meet installation codes stipulated in The National Electrical Code (ANSI-NFPA 70). Equipment that is FM-approved for intrinsic safety may be connected to barriers based on the Entity Concept. This concept permits interconnection of approved transmitters, meters and other devices in combinations, which have not been specifically examined by FM, provided that the agency's criteria are met. The combination is then intrinsically safe, if the entity concept is acceptable to the authority having jurisdiction over the installation. The entity concept criteria are as follows: The intrinsically safe devices, other than barriers, must not be a source of power. The maximum voltage  $U_i$ (VMAX) and current  $I_i$ (IMAX), and maximum power  $P_i$ (Pmax), which the device can receive and remain intrinsically safe, must be equal to or greater than the voltage ( $U_o$  or VOC or Vt) and current ( $I_o$  or ISC or It) and the power  $P_o$  which can be delivered by the barrier. The sum of the maximum unprotected capacitance ( $C_i$ ) for each intrinsically device and the interconnecting wiring must be less than the capacitance ( $C_a$ ) which can be safely connected to the barrier. The sum of the maximum unprotected inductance ( $L_i$ ) for each intrinsically device and the interconnecting wiring must be less than the inductance ( $L_a$ ) which can be safely connected to the barrier. The entity parameters  $U_o$ , VOC or Vt and  $I_o$ , ISC or It, and  $C_a$  and  $L_a$  for barriers are provided by the barrier manufacturer.

# Appendix3. IECEx Installation drawing YTA70PQI01

## IECEX

### Installation drawing YTA70PQI01



For safe installation of the YTA70P-JA/V2S and YTA70P-JB/V2S the following must be observed. The module shall only be installed by qualified personnel who are familiar with the national and international laws, directives and standards that apply to this area.

IECEX Certificate	IECEX DEK 14.0058X
Marking	Ex ia IIC T5 Ga Ex ia IIC Da
Standards:	IEC60079-11:2011, IEC60079-0: 2011, IEC60079-26:2006

Hazardous area  
Zone 0, 1, 2, 20, 21, 22

T5:  $-40 \leq T_a \leq 60^{\circ}\text{C}$

Non Hazardous Area

**Terminal:  
41,42,43,44**  
Uo: 9.6 VDC  
Io: 28 mA  
Po: 67.2 mW  
Lo: 35 mH  
Co: 3.5  $\mu\text{F}$

**Terminal:  
51,52,53,54**  
Uo: 9.6 VDC  
Io: 28 mA  
Po: 67.2 mW  
Lo: 35 mH  
Co: 3.5  $\mu\text{F}$

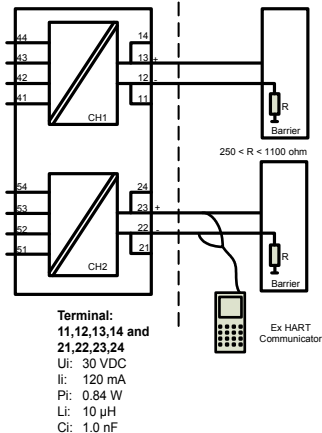

---

## IECEX

### Installation drawing YTA70PQI01

---

#### General installation instructions

To avoid risk of ignition during installation and maintenance appropriate safety measures against electrostatic discharge (ESD) are to be considered.

The sensor circuit is not infallibly galvanic isolated from the supply output circuit. However, the galvanic isolation between the circuits is capable of withstanding a test voltage of 500Vac during 1 minute.

#### For installation in a potentially explosive gas atmosphere the following instructions apply:

To avoid risk of ignition due to electrostatic discharge (ESD) the transmitter shall be mounted in an enclosure providing a degree of protection of at least IP20 according to EN/IEC 60529.

Ambient temperature range:

T5:  $-40 \leq T_a \leq 60^{\circ}\text{C}$

#### For installation in a potentially explosive dust atmosphere, the following instructions apply:

The transmitter shall be mounted in a metal enclosure or equivalent that is providing a degree of protection of at least IP6X according to EN/IEC 60529 that is suitable for the application and correctly installed. Cable entries and blanking elements shall be used that are suitable for the application and correctly installed. The surface temperature of the enclosure is equal to the ambient temperature +20K for a dust layer with a maximum thickness of 5 mm.

Ambient temperature range:

T5:  $-40 \leq T_a \leq 60^{\circ}\text{C}$

# Appendix4. CSA Installation drawing YTA70PQC01

## CSA

### Installation drawing YTA70PQC01

Hazardous (Classified ) Location  
 IS, Class I, Division 1, Group A,B,C,D T6 or  
 Ex ia IIC Ga T6 or  
 Class I, Zone 0, AEx ia IIC Ga T6

Non Hazardous Location

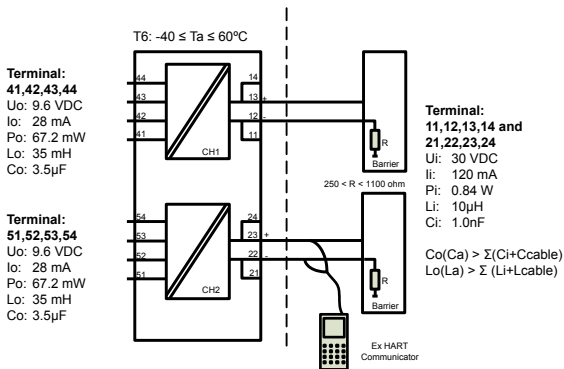

#### Installation notes.

The Transmitter must be installed in a suitable enclosure to meet installation codes stipulated in The Canadian Electrical Code (CEC) or for US in the National Electrical Code (NEC).

Channel 1 and Channel 2 are separate channels and therefore separate shielded cables shall be used for each channel.

Substitution of components may impair intrinsic safety.

# Appendix5. Label of Explosion Protected Type

## YOKOGAWA

Yokogawa Electric Corporation  
2-9-32, Nakacho, Musashino-shi  
Tokyo, 180-8750 JAPAN

TEMPERATURE TRANSMITTER

Model: YTA70P

Suffix: -JA/V2S



READ IM 01C50C05-01



0344



Supply: 8.0...30V, Output: 4...20mA

11: out ch1 supply -  
12: out ch1 HART<sup>®</sup>  
13: out ch1 HART<sup>®</sup>  
14: out ch1 supply+

41: in ch1	TC -	mV	RTD	-3w/ -4w
42: in ch1	CJC		RTD	-2w/ -3w/ -4w
43: in ch1	CJC		RTD	+2w/+3w/+4w
44: in ch1	TC+	mV+	RTD	+4w

**IECEx**

T5: -40°C ≤ Ta ≤ +60°C

Ex ia IIC T5 Ga

Ex ia IIIC Da

IECEx DEK 14.0058X

Installation Drawing: YTA70PQI01



T5: -40°C ≤ Ta ≤ +60°C

II 1 G Ex ia IIC T5 Ga

II 1 D Ex ia IIIC Da

DEKRA 14 ATEX0106X

Installation Drawing: YTA70PQA01



T6: -40°C ≤ Ta ≤ +60°C

IS, CL I, DIV. 1, GP ABCD T6

CL I, ZONE 0, AEx ia IIC T6

FM 3024107 Entity

Installation Drawing: YTA70PQF01



T6: -40°C ≤ Ta ≤ +60°C

IS, CL I, DIV. 1, GP ABCD T6

Ex ia IIC T6; AEx ia IIC T6

CSA 70009864

Installation Drawing: YTA70PQC01

Made in Denmark - Label No.: YTA70PS101

FA0501.ai

## Parts List for Connectors

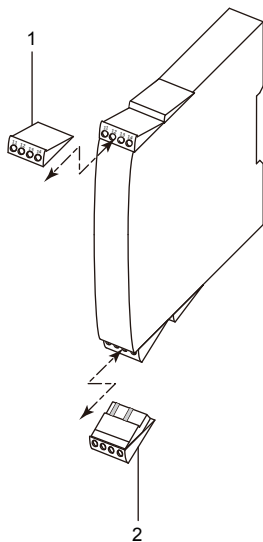

Item	Part No.	Qty	Description
1	F9168CA	1	Connector for Power supply (For general use type)
	F9168CB		Connector for Power supply (For intrinsically safe type)
2	F9168CC	1	Connector for T/C input (For general use type)
	F9168CD		Connector for RTD, Ohm, mV input (For general use type)
	F9168CE		Connector for T/C input (For intrinsically safe type)
	F9168CF		Connector for RTD, Ohm, mV input (For intrinsically safe type)

## Revision Information

- Manual No. : IM 01C50C05-01EN
- Title : YTA70P Temperature Transmitter

Edition	Date	Page	Revised item
1st	June 2014	—	New Publication
2nd	Feb. 2015	— i, ii 1-6 2-5 5-2 7-4 Appendix	Add explosion protected type Revised Add ATEX Documentation Add 2.7 Add Figure 5.2 Add ATEX, FM, IECEx, and CSA Intrinsically safe approval specifications Add Appendix



# YOKOGAWA

---

## **YOKOGAWA ELECTRIC CORPORATION**

### **Headquarters**

2-9-32, Nakacho, Musashino-shi, Tokyo, 180-8750 JAPAN  
Phone : 81-422-52-5555

### **Branch Sales Offices**

Osaka, Nagoya, Hiroshima, Kurashiki, Fukuoka, Kitakyusyu

---

## **YOKOGAWA CORPORATION OF AMERICA**

### **Head Office**

12530 West Airport Blvd, Sugar Land, Texas 77478, USA  
Phone : 1-281-340-3800 Fax : 1-281-340-3838

### **Georgia Office**

2 Dart Road, Newnan, Georgia 30265, USA  
Phone : 1-800-888-6400/ 1-770-253-7000 Fax : 1-770-254-0928

### **YOKOGAWA AMERICA DO SUL LTDA.**

Praca Acapulco, 31 - Santo Amaro, São Paulo/SP, BRAZIL, CEP-04675-190  
Phone : 55-11-5681-2400 Fax : 55-11-5681-4434

### **YOKOGAWA EUROPE B. V.**

Euroweg 2, 3825 HD Amersfoort, THE NETHERLANDS  
Phone : 31-88-4641000 Fax : 31-88-4641111

### **YOKOGAWA ELECTRIC CIS LTD.**

Grokholskiy per 13 Building 2, 4th Floor 129090, Moscow, RUSSIA  
Phone : 7-495-737-7868 Fax : 7-495-737-7869

### **YOKOGAWA CHINA CO., LTD.**

3F Tower D Cartelo Crocodile Building, No.568 West Tianshan Road,  
Shanghai 200335, CHINA  
Phone : 86-21-62396262 Fax : 86-21-62387866

### **YOKOGAWA ELECTRIC KOREA CO., LTD.**

(Yokogawa B/D, Yangpyeong-dong 4-Ga), 21, Seonyu-ro 45-gil,  
Yeongdeungpo-gu, Seoul, 150-866, KOREA  
Phone : 82-2-2628-6000 Fax : 82-2-2628-6400

### **YOKOGAWA ENGINEERING ASIA PTE. LTD.**

5 Bedok South Road, Singapore 469270, SINGAPORE  
Phone : 65-6241-9933 Fax : 65-6241-2606

### **YOKOGAWA INDIA LTD.**

Plot No.96, Electronic City Complex, Hosur Road, Bangalore - 560 100, INDIA  
Phone : 91-80-4158-6000 Fax : 91-80-2852-1442

### **YOKOGAWA AUSTRALIA PTY. LTD.**

Tower A, 112-118 Talavera Road, Macquarie Park NSW 2113, AUSTRALIA  
Phone : 61-2-8870-1100 Fax : 61-2-8870-1111

### **YOKOGAWA MIDDLE EAST & AFRICA B.S.C.(C)**

P.O. Box 10070, Manama, Building 577, Road 2516, Busaiten 225, Muharraq,  
BAHRAIN  
Phone : 973-17-358100 Fax : 973-17-336100

---